

AMERICAN AUDIO TT-Record

Turntable Mp3 Recorder
"Fast, Easy, and Reliable"



USER INSTRUCTIONS

AMERICAN AUDIO
6122 S. Eastern Ave.
Los Angeles Ca. 90040
www.AmericanAudio.us

CONTENTS

<i>ELECTRICAL SAFETY PRECAUTIONS.....</i>	<i>4</i>
<i>INSTALLATION GUIDELINES.....</i>	<i>5</i>
<i>PRODUCT INFORMATION.....</i>	<i>6</i>
<i>CUSTOMER SUPPORT.....</i>	<i>6</i>
<i>QUICK START.....</i>	<i>7</i>
<i>ASSEMBLY.....</i>	<i>8</i>
<i>SET-UP.....</i>	<i>9</i>
<i>HEADSHELL AND CARTRIDGE ASSEMBLY.....</i>	<i>9</i>
<i>PROPER TURNTABLE INSTALLATION.....</i>	<i>11</i>
<i>TO NEARM BALANCING.....</i>	<i>11</i>
<i>ANTI-SKATE.....</i>	<i>11</i>
<i>FUNCTIONS AND CONTROLS</i>	
<i>MAIN UNIT.....</i>	<i>12</i>
<i>TO NEARM ASSEMBLY.....</i>	<i>14</i>
<i>TROUBLE SHOOTING.....</i>	<i>15</i>
<i>WARRANTY.....</i>	<i>16</i>
<i>SPECIFICATIONS.....</i>	<i>17</i>



CAUTION

**Do not open -
risk of electric shock**





CAUTION: TO REDUCE THE RISK OF ELECTRIC SHOCK, DO NOT REMOVE THE COVER. THERE ARE NO USER SERVICEABLE PARTS INSIDE. REFER ALL SERVICE TO YOUR AUTHORIZED AMERICAN AUDIO® DEALER.



The lightning flash with an arrow triangular symbol is intended to alert the user to the presence of non insulated “dangerous voltage” within the products enclosure, and may be of sufficient magnitude to constitute a risk of electric shock.



The exclamation point triangular symbol is intended to alert the user to the presence of important operating and maintenance (servicing) instructions in the user manual accompanying the amplifier.

NOTE: This product satisfies FCC regulations when shielded cables and connectors are used to connect the unit to other equipment. To prevent electromagnetic interference with electrical appliances such as radios and televisions, use shielded cables and connectors for connections.

ELECTRICAL SAFETY PRECAUTIONS

WARNING: TO PREVENT FIRE OR ELECTRIC SHOCK HAZARD, DO NOT EXPOSE THIS UNIT TO RAIN, LIQUIDS, OR MOISTURE

CAUTION: TO PREVENT ELECTRIC SHOCK DO NOT USE THIS (POLARIZED) PLUG WITH AN EXTENSION CORD, RECEPTACLE, OR OTHER TYPE OF ELECTRICAL OUTLET UNLESS THE WIDE BLADES CAN BE CAREFULLY INSERTED INTO A MATCHING WIDE SLOT.

ATTENTION: POUR PREVENIR LES CHOCS ELECTRIQUES NE PAS UTILISER CETTE FICHE POLARISEE AVEC UN PROLONGATEUR, UNE PRISE DE COURANT OU UNE AUTRE SORTIE DE COURANT, SAUF SI LES LAMES PEUVENT ETRE INSEREES A FOND SANS EN LAISSER AUCUNE PARTIE A DECOUVERT.

The serial and model number for this unit is located on the rear panel. Please write down the numbers here and retain for future reference.

Model No. _____

Serial No. _____

Purchase Notes:

Date of Purchase _____

Dealer Name _____

Dealer Address _____

Dealer Phone _____

1. Heat - The turntable should be situated away from heat sources such as radiators, heat registers, stoves, or other appliances (including amplifiers) that produce heat.
2. Do not let insecticides, benzene, or thinner come in contact with the surface of the unit.
3. Never disassemble or modify your unit in any way, doing so will void your manufacturer's warranty.
4. Never plug this unit in to a dimmer pack
5. Do not attempt to operate this unit if it becomes damaged in any way.
6. This unit is intended for indoor use only, use of this product outdoors voids all warranties.
7. Always mount this unit in safe and stable matter.
8. Disconnect from main power before making any type of connection.
9. Cleaning - The turntable should be cleaned only as recommended by the manufacturer. Use a soft cloth to wipe down the outside of the unit. For stubborn stains moisten a soft cloth with glass cleaner or other mild detergent to wipe away any stains. Use a soft cloth to wipe any residual cleaner. Never use volatile cleaners such as benzene, solvent, or thinner to clean your unit, these cleaners will damage the unit's surface.

CAUTION:

1. Handle the power supply cord carefully. Do not damage or deform; it may cause electric shock or malfunction when used. Hold plug attachment when removing from wall outlet. Do not pull on the cord.
2. To avoid electric shock, do not open the top cover when the unit is plugged in. If problems occur with the unit, call American Audio® customer support.
3. Do not place metal objects or spill liquid inside or on the turntable. Electric shock or malfunction may occur.

ELECTRICAL SAFETY PRECAUTIONS

ELECTRICAL PRECAUTIONS



The lightning flash with arrowhead symbol, within an equilateral triangle, is intended to alert the user to the presence of uninsulated "dangerous voltage" within the product's enclosure that may be of sufficient magnitude to constitute a risk of electric shock to persons.



CAUTION: TO REDUCE THE RISK OF ELECTRIC SHOCK, DO NOT REMOVE THE COVER (OR BACK). THERE ARE NO USER SERVICEABLE PARTS INSIDE. REFER SERVICE TO YOUR AUTHORIZED AMERICAN AUDIO® SERVICE TECHNICIAN.



The exclamation point within an equilateral triangle is intended to alert the user to the presence of important operating and maintenance (servicing) instructions in the literature accompanying the appliance.

IMPORTANT SAFETY INSTRUCTIONS

READ INSTRUCTIONS — All the safety and operating instructions should be read before the product is operated.

RETAIN INSTRUCTIONS — The safety and operating instructions should be retained for future reference.

HEED WARNINGS — All warnings on the product and in the operating instructions should be adhered to.

FOLLOW INSTRUCTIONS — All operating and use instructions should be followed.

CLEANING — The product should be cleaned only with a polishing cloth or a soft dry cloth. Never clean with furniture wax, benzene, insecticides or other volatile liquids since they may corrode the cabinet.

ATTACHMENTS — Do not use attachments not recommended by the product manufacturer as they may cause hazards.

WATER AND MOISTURE — Do not use this product near water — for example, near a bathtub, wash bowl, kitchen sink, or laundry tub; in a wet basement; or near a swimming pool; and the like.

ACCESSORIES — Do not place this product on an unstable cart, stand, tripod, bracket, or table. The product may fall, causing serious injury to a child or adult, and serious damage to the product. Use only with a cart, stand, tripod, bracket, or table recommended by the manufacturer, or sold with the product. Any mounting of the product should follow the manufacturer's instructions, and should use a mounting accessory recommended by the manufacturer.

CART — A product and cart combination should be moved with care. Quick stops, excessive force, and uneven surfaces may cause the product and cart combination to overturn.



VENTILATION — Slots and openings in the cabinet are provided for ventilation and to ensure reliable operation of the product and to protect it from overheating, and these openings must not be blocked or covered. The openings should never be blocked by placing the product on a bed, sofa, rug, or other similar surface. This product should not be placed in a built-in installation such as a bookcase or rack unless proper ventilation is provided or the manufacturer's instructions have been adhered to.

POWER SOURCES — This product should be operated only from the type of power source indicated on the marking label. If you are not sure of the type of power supply to your home, consult your product dealer or local power company.

LOCATION — The appliance should be installed in a stable location.

NONUSE PERIODS — The power cord of the appliance should be unplugged from the outlet when left unused for a long period of time.

GROUNDING OR POLARIZATION

- If this product is equipped with a polarized alternating current line plug (a plug having one blade wider than the other), it will fit into the outlet only one way. This is a safety feature. If you are unable to insert the plug fully into the outlet, try reversing the plug. If the plug should still fail to fit, contact your electrician to replace your obsolete outlet. Do not defeat the safety purpose of the polarized plug.

- If this product is equipped with a three-wire grounding type plug, a plug having a third (grounding) pin, it will only fit into a grounding type power outlet. This is a safety feature. If you are unable to insert the plug into the outlet, contact your electrician to replace your obsolete outlet. Do not defeat the safety purpose of the grounding type plug.

POWER-CORD PROTECTION - Power-supply cords should be routed so that they are not likely to be walked on or pinched by items placed upon or against them, paying particular attention to cords at plugs, convenience receptacles, and the point where they exit from the product.

OUTDOOR ANTENNA GROUNDING — If an outside antenna or cable system is connected to the product, be sure the antenna or cable system is grounded so as to provide some protection against voltage surges and built-up static charges. Article 810 of the National Electrical Code, ANSI/NFPA 70, provides information with regard to proper grounding of the mast and supporting structure, grounding of the lead-in wire to an antenna discharge unit, size of grounding conductors, location of antenna-discharge unit, connection to grounding electrodes, and requirements for the grounding electrode. See Figure A.

LIGHTNING — For added protection for this product during a lightning storm, or when it is left unattended and unused for long periods of time, unplug it from the wall outlet and disconnect the antenna or cable system. This will prevent damage to the product due to lightning and power-line surges.

POWER LINES — An outside antenna system should not be located in the vicinity of overhead power lines or other electric light or power circuits, or where it can fall into such power lines or circuits. When installing an outside antenna system, extreme care should be taken to keep from touching such power lines or circuits as contact with them might be fatal.

OVERLOADING — Do not overload wall outlets, extension cords, or integral convenience receptacles as this can result in a risk of fire or electric shock.

OBJECT AND LIQUID ENTRY - Never push objects of any kind into this product through openings as they may touch dangerous voltage points or short-out parts that could result in a fire or electric shock. Never spill liquid of any kind on the product.

SERVICING — Do not attempt to service this product yourself as opening or removing covers may expose you to dangerous voltage or other hazards. Refer all servicing to qualified service personnel.

DAMAGE REQUIRING SERVICE - Unplug this product from the wall outlet and refer servicing to qualified service personnel under the following conditions:

- When the power-supply cord or plug is damaged.
- If liquid has been spilled, or objects have fallen into the product.
- If the product has been exposed to rain or water.
- If the product does not operate normally by following the operating instructions. Adjust only those controls that are covered by the operating instructions as an improper adjustment of other controls may result in damage and will often require extensive work by a qualified technician to restore the product to its normal operation.
- If the product has been dropped or damaged in any way.
- When the product exhibits a distinct change in performance — this indicates a need for service.

REPLACEMENT PARTS — When replacement parts are required, be sure the service technician has used replacement parts specified by the manufacturer or have the same characteristics as the original part. Unauthorized substitutions may result in fire, electric shock, or other hazards.

SAFETY CHECK - Upon completion of any service or repairs to this product, ask the service technician to perform safety checks to determine that the product is in proper operating condition.

WALL OR CEILING MOUNTING — The product should not be mounted to a wall or ceiling.

HEAT — The product should be situated away from heat sources such as radiators, heat registers, stoves, or other products (including amplifiers) that produce heat.

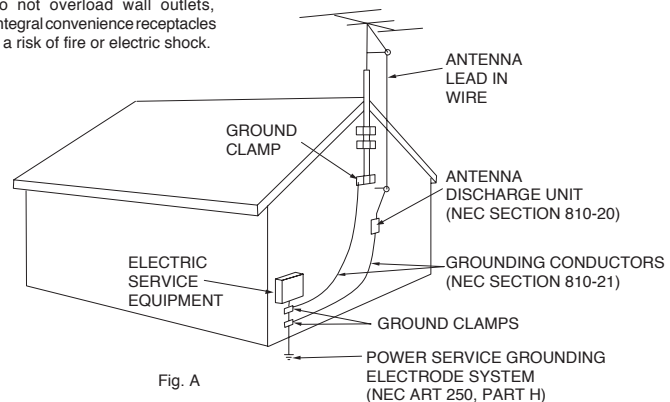

Fig. A

NEC — NATIONAL ELECTRICAL CODE

PRODUCT INFORMATION

Please carefully read and understand the instructions in this manual thoroughly before attempting to operate this unit. These instructions contain important safety information regarding the use and maintenance of this unit. Take special care to follow all warning symbols and labels both on the unit and printed in this manual. Also, Please keep this manual with the unit, for future reference.

Features:

- Metal Tone Arm
- Belt Drive Platter Motor
- Large Platter Start/Stop Button
- 2 Speeds (33 & 45 RPM)
- 45 Adapter for 7" Records
- Adjustable Feet for Leveling
- Anti-Skating Tone Arm Adjustment
- Tone Arm Holder with Lock

Customer Support: American Audio® provides a toll free customer support line, to provide set up help and to answer any question should you encounter problems during your set up or initial operation. You may also visit us on the web at www.americanaudio.us for any comments or suggestions. For service related issue please contact American Audio®. Service Hours are Monday through Friday 9:00 a.m. to 5:00 p.m. Pacific Standard Time.

Voice: (800) 322-6337

Fax: (323) 582-2941

E-mail: support@americanaudio.com

To purchase parts online visit

<http://parts.americandj.com>

Warning! To prevent or reduce the risk of electrical shock or fire, do not expose this unit to rain or moisture.

Caution! There are no user serviceable parts inside this unit. Do not attempt any repairs yourself, doing so will void your manufactures warranty. In the unlikely event your unit may require service please contact customer support. Please do not return to your dealer without first contacting customer support.

The shipping carton and packing materials are constructed of recyclable material, please recycle when ever possible.

WARRANTY INFORMATION

The TT-RECORD™ carries a ONE year (365 days) limited warranty. This warranty covers parts and labor. Please fill out the enclosed warranty card to validate your purchase and warranty. All returned service items whether under warranty or not, must be freight pre-paid and accompany a return authorization (R.A.) number. If the unit is under warranty, you must provide a copy of your proof of purchase invoice. Please contact American Audio® customer support at (800) 322-6337 for a R.A. number. All packages not displaying a R.A. number on the outside of the package will be returned to the shipper.

QUICK-START

Turntable Quick-Start:

1. Changing Platter Speed

Use the RPM selectors (5 & 6) to change the platter speeds.

2. Start/Stopping Platter

Use the Start/Stop Button (7) to start and stop playback.

3. Pitch Control

1. The pitch adjustment is a fine adjustment to the platter's RPMs.
2. The pitch adjustment is variable and may be adjusted between -10% and +10% of the platter selected speed.
3. The pitch is changed by sliding the Pitch Slider (3) in an up and down motion.

Product Service:

1. Clean the stylus periodically with a soft brush to prevent the accumulation of dust.
2. When sound becomes distorted or noisy, check the stylus. If the stylus is worn out, replace it with a new one.
3. From time to time, the turntable should be wiped down with a soft, dry cloth.
4. Volatile materials should not be used, such as: alcohol, thinner, benzine etc. They may remove the paint or damage the luster.

ASSEMBLY

This unit has been thoroughly tested and has been shipped in perfect operating condition. Carefully check the shipping carton for damage that may have occurred during shipping. If the carton appears to be damaged, carefully inspect your unit for any damage. Be sure all accessories needed to operate the unit has arrived intact. In the event damage has been found or parts are missing, please contact our toll free customer support number for further instructions. Please do not return the unit to your dealer without first contacting customer support.

Some assembly required before you can begin to use your new TT-Record. Please follow the assembly instruction below before attempting to use you new turntable.

ASSEMBLY:

Before you begin assembly please be sure all parts and accessories have arrived intact. Please use the check list below to identify and order parts and accessories.

45 RPM Adapter

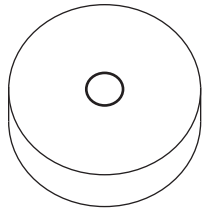

Headshell

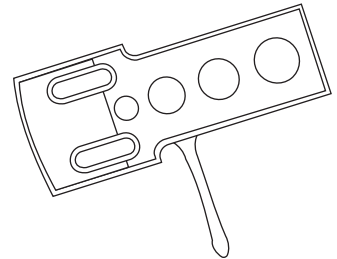

Turntable Platter

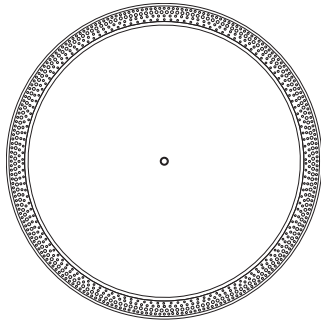

Counter Weight

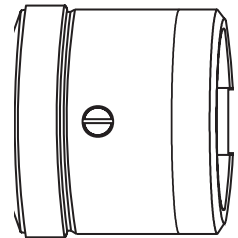

Slipmat

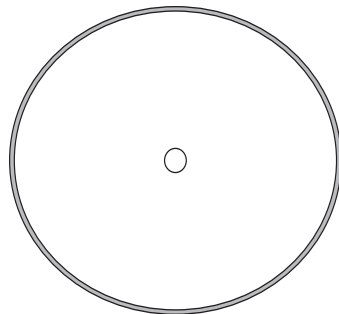

Rubber Foot

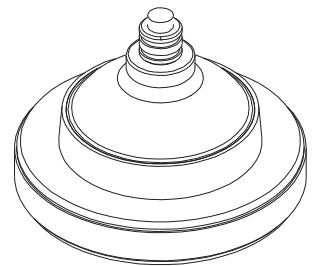

Headphone Adapter

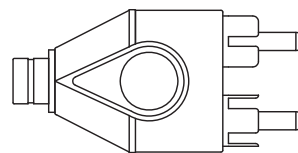

NOTES:

- Do not connect the AC power plug before assembly has been completed.
- Before turning the power on, make sure once again all the connections and power voltage settings are correct. Always turn off the power when connecting or disconnecting.
- Read this manual carefully before using the unit. Be sure to store the manual in a safe place for future reference.
- Attach a stylus cartridge to the Headshell (10) before assembling the turntable unit.

Headshell and Cartridge Assembly:

When installing a cartridge, refer to the operating instructions of that cartridge. During installation, attach the stylus protector to guard the stylus tip from damage.

Connect the Headshell (10) lead wires to the cartridge terminals. The terminals of cartridges and the Headshell (10) lead wires are color coded. Connect each lead wire to the cartridge terminals of the same color.

White (L+)	Left channel +
Blue (L-)	Left channel -
Red (R+)	Right channel +
Green (R-)	Right channel -

Turntable Assembly:

1. Removing from carton:

Carefully remove the main unit with the packing material intact from the box. Remove the packing material once the unit has been removed from the shipping carton. All accessories should be located in the packing material.

2. Turntable Platter (1):

Remove the turntable platter from the packing material and gently insert the platter into the center spindle on the base of the turntable unit.

3. Drive Hub:

Pull the belt to the lower side of the turntable over the drive hub.

4. Slipmat:

Remove the black slipmat from the packaging and place it on the Platter (1).

5. Headshell (10):

Insert the Headshell (12) into the front end of the Tonearm Assembly (2). While holding Headshell (10) firmly into the front end of the tonearm assembly, turn the Headshell Locking Nut (11) counter-clockwise to firmly secure the Headshell (10) to Tonearm Assembly (2).

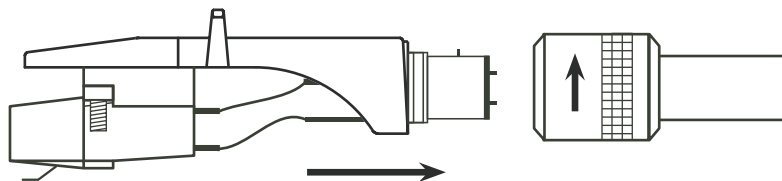

SET-UP

6. Counterweight (16):

Locate and remove the tonearm Counterweight (16) from the packaging. Slide Counterweight (16) onto the rear of the Tonearm (12). Turn it lightly and it will screw onto the rear shaft of the tonearm.

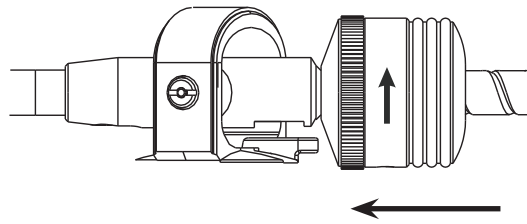

Anti-Skate:

The anti-skate adjustment prevents the Tonearm Assembly (2) from skipping across the record from the centrifugal force that is caused spinning rotation of the Platter (1). The Anti-Skating (15) control knob should be set to the same value as the stylus pressure. For example if your Counterweight (16) is set to 2.5 grams the Anti-Skate (15) value should also be set to 2.5.

Turntable Connections:

1. Connect the unit's stereo output leads to a receiver or mixer. The red phono terminal represents the right output channel and the white terminal represents the left output channel.



2. Connect the power core to matching outlet for your area. Only connect the power cord after the all other connections have been made.

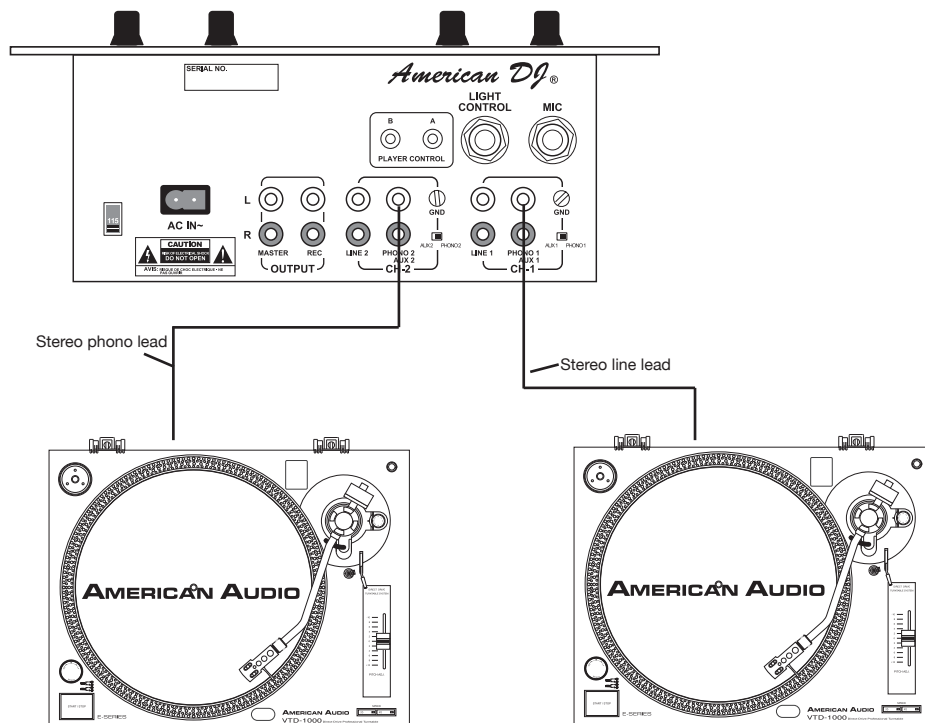

SET-UP

Turntable Installation:

1. Do not place the unit in a location where it will be exposed to direct sunlight or near any type of heating appliance.
2. Do not place the unit in a location where there is high humidity or a lot of dust.
3. Cartridge may pick up slight sound pressure or vibrations of near by speakers. For best results, do not install this unit too close to speakers.
4. Install this unit on a horizontal surface that is stable and vibration free.
5. The rubber feet have been specially designed to isolate the unit from excess vibration. The feet may also be used to stabilize the main body horizontally. Adjust the height of the unit by turning the feet in a clockwise or counter-clockwise direction.

CONTROLS AND FUNCTIONS

Main Unit



1. Platter -

This platter connects directly to the center spindle (8). The platter and center spindle (8) holds a vinyl record perfectly center. The platter also spins the record at a consistent speed.

2. Tone Arm Assembly -

This assembly will be explained in tonearm section on the page 14.

3. Pitch Adjust Slider -

This slider is used to adjust the playback pitch percentage (platter speed). Use this slider to match the BPM's of this unit to that of another music source.

4. Record/Stop Button -

This button is used to start and stop recording to your USB stick.

5. 45-rpm Speed Selector Buttons -

Engaging this button will rotate the platter at 45 RPMs. A function LED will glow when this function is activated.

CONTROLS AND FUNCTIONS

6. 33-rpm Speed Selector Button -

Engaging this button will rotate the platter at 33 revolutions per a minute (RPMs). A function LED will glow when this function is activated.

7. START/STOP Button -

This over sized push button controls platter motion. When the unit is turned on the platter will not automatically begin to spin. Pressing the button once will engage the high torque motor and spin the platter, pressing this again will stop the platter.

8. Center Spindle -

This spindle holds the turntable platter (1) and records stable and centered.

9. USB Port -

Insert your USB stick for recording.

RECORDING TO YOUR USB STICK:

1. Select your desired record and load it onto the turntable. Insert your USB stick into the USB port (9).
2. If you only want to record a desired song locate the song on the record.
3. Start playing the record by pressing the START/STOP button (7) and press the RECORD/STOP button (4) to start recording to your USB stick.
4. After you finished recording your desired material, press the RECORD/STOP button (4) for the USB stick. Then press the START/STOP button (7) to stop the record.

CONTROLS AND FUNCTIONS

Tonearm Assembly

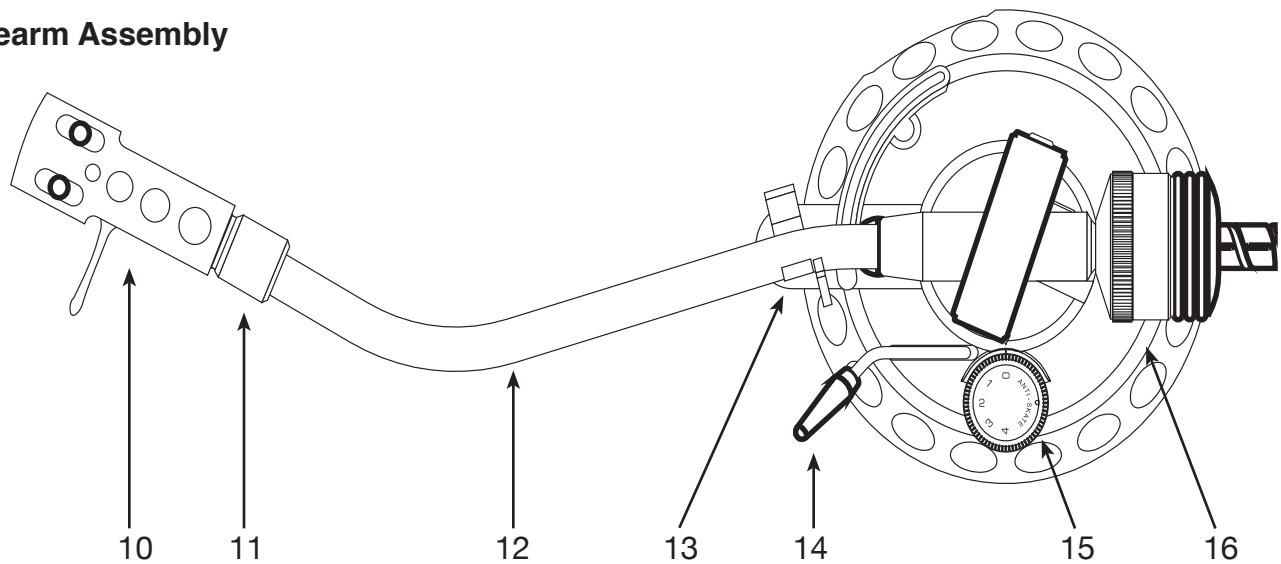

10. Stylus Headshell -

The included headshell is used to connect your stylus with the tone arm.

11. Headshell Locking Nut -

After attaching the headshell to the tone arm, this locking nut will securely hold the headshell to the tone arm.

12. Tone Arm -

The tone arm is the mechanism that holds the headshell and stylus allowing it to glide across a record.

13. Tonearm Clamp and Rest -

Use this rest to safely hold the tone arm in position during non use and transportation.

14. Tonearm Lever -

This lever is used to safely elevate the tone arm above a record surface without endangering a records surface.

15. Anti-Skate Control -

The anti-skate applies inward force to the tone arm to prevent outward skipping across the record due to the centrifugal force cause by platter rotation. The anti-skate value should be equally to that of the stylus counterweight pressure.

16. Counterweight -

The counterweight adjustment applies the proper downward pressure on the stylus.

TROUBLE SHOOTING

Trouble Shooting: Listed below are common problems you may encounter, and solutions.

The turntable has no power:

1. Check the power cord, is it connected?

The sound is distorted or on one side only:

1. Make sure that the cartridge is properly wired. Refer to the Cartridge Assembly section on page 9.
2. Check if the stylus is worn out.
3. Make sure that the cartridge is making a proper connection. If need be, remove the cartridge and clean the contacts on the back with Isopropyl alcohol, and reinsert it.
4. Check if the selector switch on the mixer is set to "Line" instead of "Phono." If so, switch the selector switch to "Phono." Always connect the turntable RCA cord to the Phone input on a mixer.
5. Check the RCA cables, are they connected properly? When the RCA cables are frequently connected and disconnected, they may become damaged and need to be replaced.

The sound level is very low:

1. Is the turntable connected to a device with a PHONO preamp. Connect the turntable to a preamp mixer that has a PHONO input. Make sure the turntable is connected to the PHONO input, **NOT** AUX or LINE.

The turntable skips consistantly:

1. Is the turntable on a unstable surface. Refer to Turntable Installation on page 11.
2. Check if the tonearm is balanced properly. Refer to Tonearm Balance and Stylus Pressure on page 11.
3. Check if the stylus is worn out.
4. Check your records, are they warped?

WARRANTY

1-YEAR LIMITED WARRANTY

- A. American Audio® hereby warrants, to the original purchaser, American Audio® products to be free of manufacturing defects in material and workmanship for a period of 1 Year (365 days) from the date of purchase. This warranty shall be valid only if the product is purchased within the United States of America, including possessions and territories. It is the owner's responsibility to establish the date and place of purchase by acceptable evidence, at the time service is sought.
- B. For warranty service, send the product only to the American Audio® factory. All shipping charges must be pre-paid. If the requested repairs or service (including parts replacement) are within the terms of this warranty, American Audio® will pay return shipping charges only to a designated point within the United States. If the entire instrument is sent, it must be shipped in its original package. No accessories should be shipped with the product. If any accessories are shipped with the product, American Audio® shall have no liability whatsoever for loss of or damage to any such accessories, nor for the safe return thereof.
- C. This warranty is void if the serial number has been altered or removed; if the product is modified in any manner which American Audio® concludes, after inspection, affects the reliability of the product; if the product has been repaired or serviced by anyone other than the American Audio® factory unless prior written authorization was issued to purchaser by American Audio®; if the product is damaged because not properly maintained as set forth in the instruction manual.
- D. This is not a service contract, and this warranty does not include maintenance, cleaning or periodic check-up. During the period specified above, American Audio® will replace defective parts at its expense, and will absorb all expenses for warranty service and repair labor by reason of defects in material or workmanship. The sole responsibility of American Audio® under this warranty shall be limited to the repair of the product, or replacement thereof, including parts, at the sole discretion of American Audio®. All products covered by this warranty were manufactured after January 1, 1990, and bear identifying marks to that effect.
- E. American Audio® reserves the right to make changes in design and/or improvements upon its products without any obligation to include these changes in any products theretofore manufactured.
- F. No warranty, whether expressed or implied, is given or made with respect to any accessory supplied with products described above. Except to the extent prohibited by applicable law, all implied warranties made by American Audio® in connection with this product, including warranties of merchantability or fitness, are limited in duration to the warranty period set forth above. And no warranties, whether expressed or implied, including warranties of merchantability or fitness, shall apply to this product after said period has expired. The consumer's and or Dealer's sole remedy shall be such repair or replacement as is expressly provided above; and under no circumstances shall American Audio® be liable for any loss or damage, direct or consequential, arising out of the use of, or inability to use, this product.
- G. This warranty is the only written warranty applicable to American Audio® Products and supercedes all prior warranties and written descriptions of warranty terms and conditions heretofore published.

SPECIFICATIONS

GENERAL

Model:	American Audio® TT-Record - Turntable Mp3 Recorder
System:	2-Speed Belt Drive Phono Turntable
Dimensions:	449 (W) x 370 (D) x 145 (H) mm
Installation:	Place on flat surface or mount in flat case
Weight:	8.3 Lbs. / 3.8 Kgs
Power supply:	AC 115/230V, 50/60Hz User Selectable Single Voltage: AC 100V, 50/60Hz (Japan) AC 110V, 60Hz (Colombia) AC 120V, 60Hz (U.S.A. and Canada) AC 127V, 60Hz (Mexico) AC 220V, 50Hz (Chile and Argentina) AC 220V, 60Hz (Philippines and Korea) AC 230V, 50Hz (Europe, New Zealand, South Africa, and Singapore) AC 240V, 50Hz (Australia and U.K.)
Power consumption:	9W
Environmental conditions:	Operational Temperature: 5 to 35°C (41 to 95°F) Operational Humidity: 45 to 85% RH (non-condensation) Storage Temperature: -10 to 60°C (4 to 140°F)
Accessories:	Instruction Manual, Connecting Cord, Cartridge, Counter Weight Headshell, AC Cord, Slipmat, RCA Cable 45 Adapter

TURNTABLE SECTION

Type:	2-Speed Fully Manual
Motor:	DC Motor
Driving Method:	Belt Drive
Turntable Platter:	330mm dia. Aluminum Diecast
Speeds:	33 1/3 and 45-rpm
Wow and Flutter:	Less than 0.2% WRMS (JIS WTD) with 33 1/3rpm
S/N Ratio:	More than 55dB (DIN-B)
Pitch Controls:	+/- 10%
Starting Time:	Less than 1 sec. with 33 1/3
Braking Time:	Less than 1 sec. with 33 1/3
Time for Speed Change:	Less than 1 sec. from 33 1/3 to 45 rpm. Less than 1 sec. from 45 to 33 1/3 rpm.
USB Function:	USB rec. Function (only for Mp3 format)

TONARM SECTION

Type:	Static balanced S-shaped tonearm with detachable headshell
Effective Arm Length:	230.5mm
Overhang:	10mm
Tracking Error Angle:	Less than 3 degree
Applicable Cartridge Weight:	6-10g
Anti-skating Range:	0~4g
Phono Output Level:	1.5~3.6mV at 1KHz 5cm/sec
Line Output Level:	90~216mV at 1KHz 5cm/sec
Frequency Response:	20Hz - 20KHz
Channel Separation:	More than 15 dB
Channel Balance:	Within 2.5dB at 1KHz
Needle Pressure range:	3~4g
High of Cue (First Track):	6~10.5mm
Descend of Cue:	1~3sec

©American Audio®
American DJ® Group of Companies World Headquarters:
6122 S. Eastern Ave. Los Angeles, CA 90040 USA
Tel: 323-582-2650 Fax: 323-582-2610
Web: www.americanaudio.us E-mail: info@americanaudio.us